

**B4M36DS2, BE4M36DS2: Database Systems 2**

<http://www.ksi.mff.cuni.cz/~svoboda/courses/201-B4M36DS2/>

Lecture 2

# Data Formats

**Martin Svoboda**

[martin.svoboda@fel.cvut.cz](mailto:martin.svoboda@fel.cvut.cz)

5. 10. 2020

**Charles University**, Faculty of Mathematics and Physics

**Czech Technical University in Prague**, Faculty of Electrical Engineering

# Lecture Outline

## Data formats

- XML – Extensible Markup Language
- JSON – JavaScript Object Notation
- BSON – Binary JSON
- RDF – Resource Description Framework
- CSV – Comma-Separated Values

# XML

Extensible Markup Language

# Introduction

**XML** = *Extensible Markup Language*

- **Representation and interchange of semi-structured data**
  - + a family of related technologies, languages, specifications, ...
- Derived from **SGML**, developed by **W3C**, started in 1996
- Design goals
  - Simplicity, generality and usability across the Internet
- File extension: **\*.xml**, content type: `text/xml`
- Versions: 1.0 and 1.1
- W3C recommendation
  - <http://www.w3.org/TR/xml11/>

# Example

```
<?xml version="1.1" encoding="UTF-8"?>
<movie year="2007">
  <title>Medvídek</title>
  <actors>
    <actor>
      <firstname>Jiří</firstname>
      <lastname>Macháček</lastname>
    </actor>
    <actor>
      <firstname>Ivan</firstname>
      <lastname>Trojan</lastname>
    </actor>
  </actors>
  <director>
    <firstname>Jan</firstname>
    <lastname>Hřebejk</lastname>
  </director>
</movie>
```

# Document Structure

## Document

- **Prolog**: XML version + some other stuff
- Exactly one **root element**
  - Contains other nested elements and/or other content

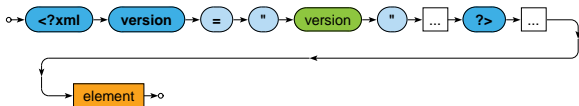

## Example

```
<?xml version="1.1" encoding="UTF-8"?>
<movie>
  ...
</movie>
```

# Constructs

## Element

- Marked using **opening and closing tags**
  - ... or just an abbreviated tag in case of empty elements
- Each element can be associated with a **set of attributes**

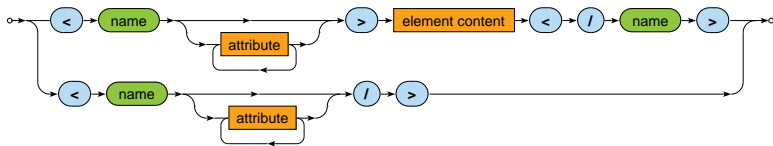

## Examples

```
<title>...</title>  
<actors/>
```

# Constructs

## Types of element content

- **Empty** content
- **Text** content
- **Element** content
  - Sequence of nested elements
- **Mixed** content
  - Elements arbitrarily interleaved with text values

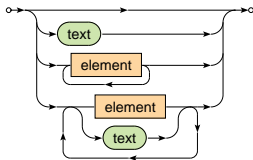



# Constructs

## Attribute

- Name-value pair



## Escaping sequences (predefined entities)

- Used within values of attributes or text content of elements
- E.g.:
  - `&lt;` for `<`
  - `&gt;` for `>`
  - `&quot;` for `"`
  - ...

# XML Conclusion

## XML constructs

- Basic: **element**, **attribute**, **text**
- Additional: **comment**, **processing instruction**, ...

## Schema languages

- DTD, XSD (*XML Schema*), RELAX NG, Schematron

## Query languages

- XPath, XQuery, XSLT

## XML formats = particular languages

- XSD, XSLT, XHTML, DocBook, ePUB, SVG, RSS, SOAP, ...

# JSON

JavaScript Object Notation

# Introduction

**JSON** = *JavaScript Object Notation*

- **Open standard for data interchange**
- Design goals
  - **Simplicity:** text-based, easy to read and write
  - **Universality:** **object** and **array** data structures
    - Supported by majority of modern programming languages
    - Based conventions of the C-family of languages (C, C++, C#, Java, JavaScript, Perl, Python, ...)
- Derived from JavaScript (but language independent)
- Started in 2002
- File extension: **\*.json**
- Content type: **application/json**
- <http://www.json.org/>

# Example

```
{
  "title" : "Medvídek",
  "year" : 2007,
  "actors" : [
    {
      "firstname" : "Jiří",
      "lastname" : "Macháček"
    },
    {
      "firstname" : "Ivan",
      "lastname" : "Trojan"
    }
  ],
  "director" : {
    "firstname" : "Jan",
    "lastname" : "Hřebejk"
  }
}
```

# Data Structure

## Object

- **Unordered** collection of name-value pairs (**properties**)
  - Correspond to structures such as objects, records, structs, dictionaries, hash tables, keyed lists, associative arrays, ...
- Values can be of different types, **names should be unique**

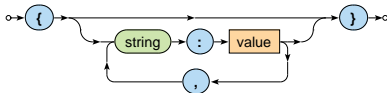

## Examples

- { "name" : "Ivan Trojan", "year" : 1964 }
- { }

# Data Structure

## Array

- **Ordered collection of values**
  - Correspond to structures such as arrays, vectors, lists, sequences, ...
- Values can be of different types, duplicate values are allowed

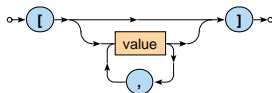

## Examples

- [ 2, 7, 7, 5 ]
- [ "Ivan Trojan", 1964, -5.6 ]
- [ ]

# Data Structure

## Value

- Unicode **string**
  - Enclosed with double quotes
  - Backslash escaping sequences
  - Example: `"a \n b \" c \\ d"`
- **Number**
  - Decimal integers or floats
  - Examples: `1`, `-0.5`, `1.5e3`
- **Nested object**
- **Nested array**
- **Boolean** value: `true`, `false`
- Missing information: `null`

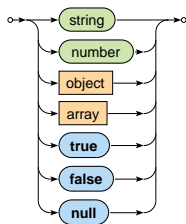



# JSON Conclusion

## JSON constructs

- Collections: **object**, **array**
- Scalar values: **string**, **number**, **boolean**, **null**

## Schema languages

- JSON Schema

## Query languages

- JSONiq, JMESPath, JAQL, ...

# BSON

Binary JSON

# Introduction

**BSON** = *Binary JSON*

- **Binary-encoded serialization of JSON documents**
  - Extends the set of basic data types of values offered by JSON (such as a string, ...) with a few new specific ones
- Design characteristics: **lightweight, traversable, efficient**
- Used by **MongoDB**
  - Document NoSQL database for JSON documents
  - Data storage and network transfer format
- File extension: **\*.bson**
- <http://bsonspec.org/>

# Example

## JSON

```
{ "title" : "Medvídek", "year" : 2007 }
```

## BSON

```
24 00 00 00 02 74 69 74 6C 65 00 0A 00 00 00 4D 65 64 76 C3 AD 64 65 6B  
00 10 79 65 61 72 00 D7 07 00 00 00
```

# Example

## JSON

```
{  
  "title" : "Medvídek",  
  "year" : 2007  
}
```

## BSON

```
24 00 00 00  
02 74 69 74 6C 65 00 0A 00 00 00 4D 65 64 76 C3 AD 64 65 6B 00  
10 79 65 61 72 00 D7 07 00 00  
00
```

# Document Structure

**Document** = serialization of **one JSON object or array**

- JSON object is serialized directly
- JSON array is first transformed to a JSON object
  - Property names derived from numbers of positions
  - E.g.:  

```
[ "Trojan", "Svěrák" ] →  
{ "0" : "Trojan", "1" : "Svěrák" }
```
- Structure
  - **Document size** (total number of bytes)
  - Sequence of **elements** (encoded JSON properties)
  - Terminating hexadecimal 00 byte

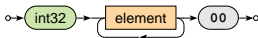

# Document Structure

**Element** = serialization of **one JSON property**

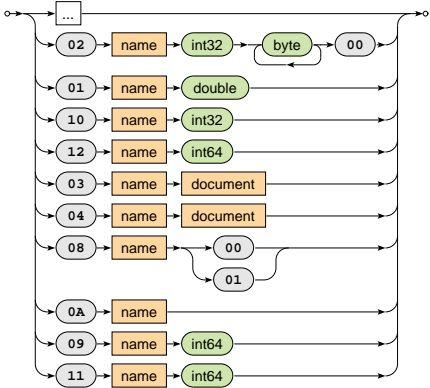

# Document Structure

**Element** = serialization of **one JSON property**

- Structure
  - **Type selector**
    - 02 (**string**)
    - 01 (double), 10 (32-bit **integer**), 12 (64-bit integer)
    - 03 (**object**), 04 (**array**)
    - 08 (**boolean**)
    - 0A (**null**)
    - 09 (datetime), 11 (timestamp)
    - ...
  - **Property name**
    - Unicode string terminated by 00



- **Property value**



# **RDF**

Resource Description Framework

# Introduction

**RDF** = *Resource Description Framework*

- Language for **representing information about resources** in the World Wide Web
  - + a family of related technologies, languages, specifications, ...
  - Used in the context of the **Semantic Web, Linked Data, ...**
- Developed by **W3C**
- Started in 1997
- Versions: 1.0 and 1.1
- W3C recommendations
  - <https://www.w3.org/TR/rdf11-concepts/>
    - Concepts and Abstract Syntax
  - <https://www.w3.org/TR/rdf11-mt/>
    - Semantics

# Statements

## Resource

- Any real-world entity
  - **Referents** = **resources identified by IRI**
    - E.g. physical things, documents, abstract concepts, ...
  - **Values** = **resources for literals**
    - E.g. numbers, strings, ...

## Statement about resources = one RDF **triple**

- Three components: **subject**, **predicate**, and **object**

## Examples

```
<http://db.cz/movies/medvidek>  
<http://db.cz/terms#actor>  
<http://db.cz/actors/trojan> .
```

```
<http://db.cz/movies/medvidek>  
<http://db.cz/terms#year>  
"2007" .
```

# Statements

## Triple components

- **Subject**
  - Describes a resource the given statement is about
  - IRI or blank node identifier
- **Predicate**
  - Describes the property or characteristic of the subject
  - IRI
- **Object**
  - Describes the value of that property
  - IRI or blank node identifier or literal

*Although triples are inspired by natural languages, they have nothing to do with processing of natural languages*

# Example

```
<http://db.cz/movies/medvidek>
  <http://db.cz/terms#actor> <http://db.cz/actors/machacek> .

<http://db.cz/movies/medvidek>
  <http://db.cz/terms#actor> <http://db.cz/actors/trojan> .

<http://db.cz/movies/medvidek>
  <http://db.cz/terms#year> "2007" .

<http://db.cz/movies/medvidek>
  <http://db.cz/terms#director> _:n18 .

_:n18
  <http://db.cz/terms#firstname> "Jan" .

_:n18
  <http://db.cz/terms#lastname> "Hřebejk" .
```

# Identifiers and Literals

**IRI** = *Internationalized Resource Identifier*

- Absolute (not relative) IRIs with optional fragment identifiers
- RFC 3987
- Unicode characters
- Examples
  - `http://db.cz/movies/medvidek`
  - `http://db.cz/terms#actor`
  - `mailto:svoboda@ksi.mff.cuni.cz`
  - `urn:issn:0167-6423`
- **URLs are often used** in practice → information about given resources are then intended to be published / retrieved via standard HTTP

# Identifiers and Literals

## Literals

- Plain values
  - E.g.: "Medvídek", "2007"
- Typed values
  - E.g.: "Medvídek"^^xs:string, "2007"^^xs:integer
  - XML Schema simple data types are adopted and used
- Strings with language tags
  - E.g.: "Medvídek"@cs
- *Types and language tags cannot be mutually combined*

# Identifiers and Literals

## Blank node identifiers

- **Blank nodes** (anonymous resources)
  - Allow to express statements about resources without explicitly naming (identifying) them
- **Blank node identifiers** only have local scope of validity
  - E.g. within a given file, query expression, ...
- Particular syntax depends on a serialization format
  - E.g.: `_:node18`



# Data Model

## Directed labeled multigraph

- Vertices
  - **One vertex for each IRI or literal value**
- Edges
  - **One edge for each individual triple**
  - Edges are directed  $subject \xrightarrow{predicate} object$
  - Property names (predicate IRIs) are used as edge labels

# Example

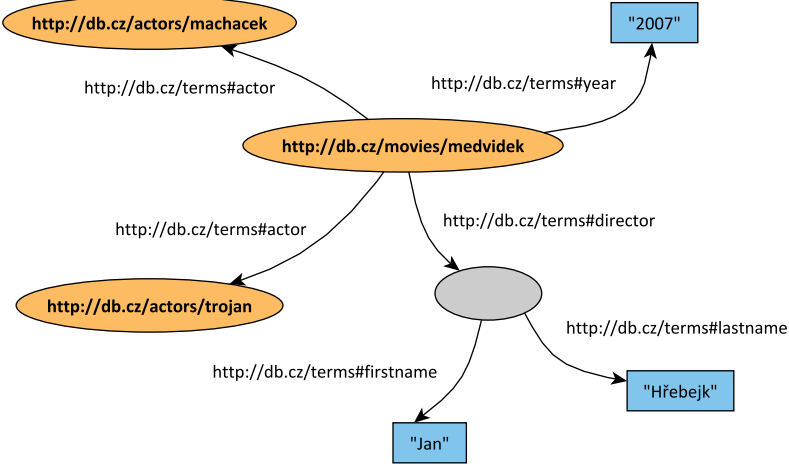

# Serialization

## Available approaches

- **N-Triples** notation
  - <https://www.w3.org/TR/n-triples/>
- **Turtle** notation (*Terse RDF Triple Language*)
  - <https://www.w3.org/TR/turtle/>
- **RDF/XML** notation
  - XML syntax for RDF
  - <https://www.w3.org/TR/rdf-syntax-grammar/>
- **JSON-LD** notation
  - JSON-based serialization for Linked Data
  - <https://www.w3.org/TR/json-ld/>
- ...

# N-Triples Notation

RDF **N-Triples** notation = *A line-based syntax for an RDF graph*

- Simple, line-based, plain text format
- File extension: **\*.rdf**
- <https://www.w3.org/TR/n-triples/>

Example

- *Already presented...*

**Document**

- Statements are terminated by dots, delimited by EOL

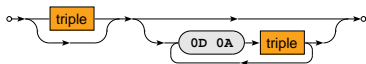

# N-Triples Notation

## Statement

- Individual triple components are delimited by spaces



## Triple components: subject, predicate, object

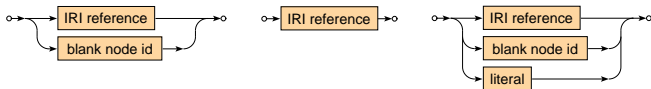

# N-Triples Notation

## IRI reference

- IRIs are enclosed in angle brackets



## Blank node identifier



## Literal

- Literals are enclosed in double quotes

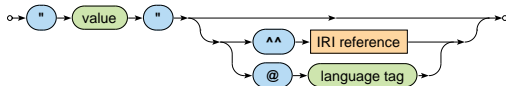

# Turtle Notation

**Turtle** = *Terse RDF Triple Language*

- Compact text format, various abbreviations for common usage patterns
- File extension: **\*.ttl**
- Content type: text/turtle
- <https://www.w3.org/TR/turtle/>

Example

```
@prefix i: <http://db.cz/terms#> .
@prefix m: <http://db.cz/movies/> .
@prefix a: <http://db.cz/actors/> .
m:medvidek
  i:actor a:machacek , a:trojan ;
  i:year "2007" ;
  i:director [ i:firstname "Jan" ; i:lastname "Hřebejk" ] .
```

# Turtle Notation

## Document

- Contains a **sequence of triples and/or declarations**
- Prefix declarations
  - **Prefixed names** can then be used instead of full IRI references
- Groups of triples
  - Individual groups are terminated by dots

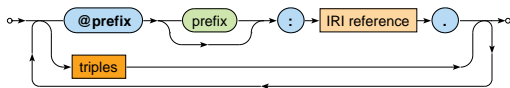



# Turtle Notation

## Triples

- Triples sharing the same subject and object or at least the same subject can be *grouped* together
  - **object** list for a **shared subject and predicate**
  - **predicate-object** list for a **shared subject**
- Brackets can be used to define blank nodes

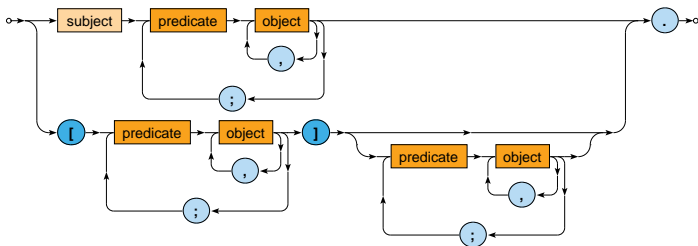

# Turtle Notation

**Triple components:** subject, predicate, object

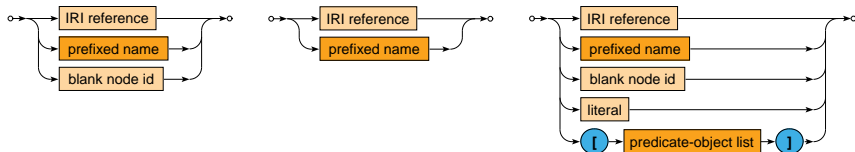

**IRI reference / prefixed name**

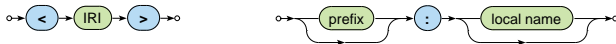

# Turtle Notation

## Literal

- Traditional literals  
+ new abbreviated forms of numeric and boolean literals

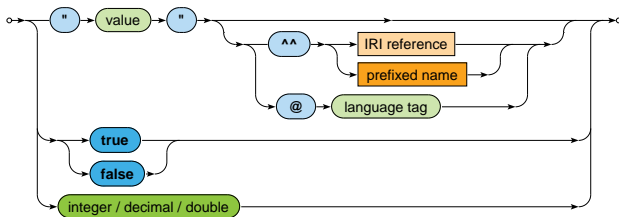

# Example

## Example revisited

```
@prefix i: <http://db.cz/terms#> .
@prefix m: <http://db.cz/movies/> .
@prefix a: <http://db.cz/actors/> .
m:medvidek
  i:actor a:machacek , a:trojan ;
  i:year "2007" ;
  i:director [ i:firstname "Jan" ; i:lastname "Hřebejk" ] .
```

# RDF Conclusion

## RDF statements

- Subject, predicate, and object components

## Schema languages

- RDFS (*RDF Schema*)
- OWL (*Web Ontology Language*)

## Query languages

- SPARQL (*SPARQL Protocol and RDF Query Language*)

# CSV

Comma-Separated Values

# Introduction

**CSV** = *Comma-Separated Values*

- Unfortunately **not fully standardized**
  - Different field separators (commas, semicolons)
  - Different escaping sequences
  - No encoding information
- RFC 4180, RFC 7111
- File extension: **\*.csv**
- Content type: `text/csv`

# Example

```
firstname,lastname,year
```

```
Ivan,Trojan,1964
```

```
Jiří,Macháček,1966
```

```
Jitka,Schneiderová,1973
```

```
Zdeněk,Svěrák,1936
```

```
Anna,Geislerová,1976
```



# Document Structure

## Document

- Optional **header** + list of **records**

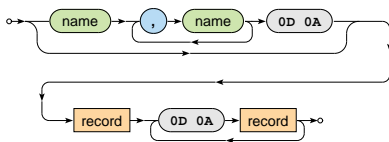

## Record

- Comma separated list of **fields**

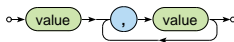



# Lecture Conclusion

## Data formats

- Tree: **XML, JSON**
- Graph: **RDF**
- Relational: **CSV**

## Binary serializations

- **BSON**