

NDBI006: Query Languages II

<http://www.ksi.mff.cuni.cz/~svoboda/courses/222-NDBI006/>

Lecture

MongoDB

Martin Svoboda

martin.svoboda@matfyz.cuni.cz

18. 4. 2023

Charles University, Faculty of Mathematics and Physics

Lecture Outline

Document databases

- Introduction

Data formats

- JSON, BSON

MongoDB

- Data model
- CRUD operations
 - **Insert, update, remove**
 - **Find:** projection, selection, modifiers
- Index structures
- MapReduce

Document Stores

Data model

- **Documents**
 - Self-describing
 - **Hierarchical tree structures** (JSON, XML, ...)
 - Scalar values, maps, lists, sets, nested documents, ...
 - Identified by a **unique identifier** (key, ...)
- Documents are **organized into collections**

Query patterns

- Create, update or remove a document
- **Retrieve documents according to complex query conditions**

Observation

- Extended key-value stores where the value part is examinable

JSON

JavaScript Object Notation

Introduction

JSON = *JavaScript Object Notation*

- **Open standard for data interchange**
- Design goals
 - **Simplicity:** text-based, easy to read and write
 - **Universality:** **object** and **array** data structures
 - Supported by majority of modern programming languages
 - Based conventions of the C-family of languages (C, C++, C#, Java, JavaScript, Perl, Python, ...)
- Derived from JavaScript (but language independent)
- Started in 2002
- File extension: ***.json**
- Content type: **application/json**
- <http://www.json.org/>

Example

```
{
  "title" : "Medvídek",
  "year" : 2007,
  "actors" : [
    {
      "firstname" : "Jiří",
      "lastname" : "Macháček"
    },
    {
      "firstname" : "Ivan",
      "lastname" : "Trojan"
    }
  ],
  "director" : {
    "firstname" : "Jan",
    "lastname" : "Hřebejk"
  }
}
```

Data Structure

Object

- **Unordered** collection of name-value pairs (**properties**)
 - Correspond to structures such as objects, records, structs, dictionaries, hash tables, keyed lists, associative arrays, ...
- Values can be of different types, **names should be unique**

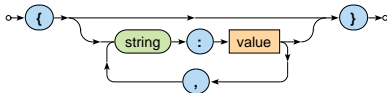

Examples

- { "name" : "Ivan Trojan", "year" : 1964 }
- { }

Data Structure

Array

- **Ordered collection of values**
 - Correspond to structures such as arrays, vectors, lists, sequences, ...
- Values can be of different types, duplicate values are allowed

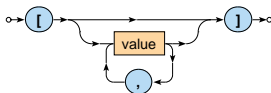

Examples

- [2, 7, 7, 5]
- ["Ivan Trojan", 1964, -5.6]
- []

Data Structure

Value

- Unicode **string**
 - Enclosed with double quotes
 - Backslash escaping sequences
 - Example: `"a \n b \" c \\ d"`
- **Number**
 - Decimal integers or floats
 - Examples: `1`, `-0.5`, `1.5e3`
- **Nested object**
- **Nested array**
- **Boolean** value: `true`, `false`
- Missing information: `null`

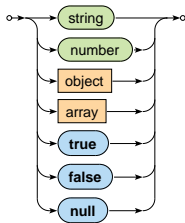

JSON Conclusion

JSON constructs

- Collections: `object`, `array`
- Scalar values: `string`, `number`, `boolean`, `null`

Schema languages

- JSON Schema

Query languages

- JSONiq, JMESPath, JAQL, ...

BSON

Binary JSON

Introduction

BSON = *Binary JSON*

- **Binary-encoded serialization of JSON documents**
 - Extends the set of basic data types of values offered by JSON (such as a string, ...) with a few new specific ones
- Design characteristics: **lightweight, traversable, efficient**
- Used by **MongoDB**
 - Document NoSQL database for JSON documents
 - Data storage and network transfer format
- File extension: ***.bson**
- <http://bsonspec.org/>

Example

JSON

```
{ "title" : "Medvídek", "year" : 2007 }
```

BSON

```
24 00 00 00 02 74 69 74 6C 65 00 0A 00 00 00 4D 65 64 76 C3 AD 64 65 6B  
00 10 79 65 61 72 00 D7 07 00 00 00
```

Example

JSON

```
{  
  "title" : "Medvídek",  
  "year" : 2007  
}
```

BSON

```
24 00 00 00  
02 74 69 74 6C 65 00 0A 00 00 00 4D 65 64 76 C3 AD 64 65 6B 00  
10 79 65 61 72 00 D7 07 00 00  
00
```

Document Structure

Document = serialization of **one JSON object or array**

- JSON object is serialized directly
- JSON array is first transformed to a JSON object
 - Property names derived from numbers of positions
 - E.g.:

```
[ "Trojan", "Svěrák" ] →  
{ "0" : "Trojan", "1" : "Svěrák" }
```
- Structure
 - **Document size** (total number of bytes)
 - Sequence of **elements** (encoded JSON properties)
 - Terminating hexadecimal 00 byte

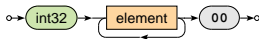

Document Structure

Element = serialization of **one JSON property**

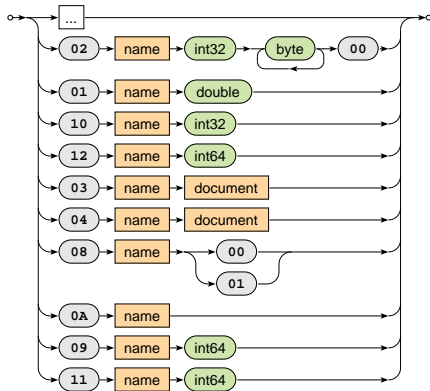

Document Structure

Element = serialization of **one JSON property**

- Structure
 - **Type selector**
 - 02 (**string**)
 - 01 (double), 10 (32-bit **integer**), 12 (64-bit integer)
 - 03 (**object**), 04 (**array**)
 - 08 (**boolean**)
 - 0A (**null**)
 - 09 (datetime), 11 (timestamp)
 - ...
 - **Property name**
 - Unicode string terminated by 00



- **Property value**

MongoDB Document Database



MongoDB

JSON document database

- <https://www.mongodb.com/>
- Features
 - Open source, high availability, eventual consistency, automatic sharding, master-slave replication, automatic failover, secondary indices, ...
- Developed by **MongoDB**
- Implemented in C++, C, and JavaScript
- Operating systems: **Windows, Linux, Mac OS X, ...**
- Initial release in 2009
 - Version we cover is 6.0.1 (August 2022)

Query Example

Collection of movies

```
{
  _id: ObjectId("1"),
  title: "Vratné lahve",
  year: 2006
}
```

```
{
  _id: ObjectId("2"),
  title: "Samotáři",
  year: 2000
}
```

```
{
  _id: ObjectId("3"),
  title: "Medvídek",
  year: 2007
}
```

Query statement

Titles of movies filmed in *2005* and later, sorted by these titles in descending order

```
db.movies.find(
  { year: { $gt: 2005 } },
  { _id: false, title: true }
).sort({ title: -1 })
```

Query result

```
{ title: "Vratné lahve" }
```

```
{ title: "Medvídek" }
```

Data Model

Database system structure

Instance → **databases** → **collections** → **documents**

- Database
- Collection
 - Collection of documents, usually of a similar structure
- Document
 - MongoDB **document** = **one JSON object**
 - I.e. even a complex JSON object with other recursively nested objects, arrays or values
 - Each document has a **unique identifier** (**primary key**)
 - Technically realized using a **top-level _id field**

Data Model

MongoDB **document**

- Internally stored in **BSON** format (*Binary JSON*)
 - Maximal allowed size 16 MB
 - **GridFS** can be used to split larger files into smaller chunks

Restrictions on fields

- **Top-level** `_id` is reserved for a **primary key**
- Field names **cannot start with** `$` and **cannot contain** `.`
 - `$` is reserved for query operators
 - `.` is used when accessing nested fields
- The order of fields is preserved
 - Except for `_id` fields that are always moved to the beginning
- **Names of fields must be unique**

Primary Keys

Features of identifiers

- **Unique** within a collection
- **Immutable** (cannot be changed once assigned)
- Can be of **any type** other than a JSON array

Key management

- Natural identifier
- Auto-incrementing number – not recommended
- UUID (*Universally Unique Identifier*)
- **ObjectId** – **special 12-byte BSON type** (the default option)
 - Small, likely unique, fast to generate, ordered, based on a timestamp, machine id, process id, and a process-local counter

Design Questions

Data modeling (in terms of **collections and documents**)

- No explicit schema is provided, nor expected or enforced
 - However...
 - documents within a collection are similar in practice
 - **implicit schema** is required nevertheless
- Challenge
 - Balancing application requirements, performance aspects, data structure, mutual relationships, query patterns, ...

Two main concepts

- References
- Embedded documents

Denormalized Data Models

Embedded documents

- Related data in a single document
 - with embedded JSON objects, so called **subdocuments**
- Pros: data manipulation (fewer queries need to be issued)
- Cons: possible data redundancies
- Suitable for **one-to-one** or **one-to-many** relationships

```
{
  _id: ObjectId("2"), title: "Samotáři", year: 2000,
  actors: [
    { firstname: "Jitka", lastname: "Schneiderová" },
    { firstname: "Ivan", lastname: "Trojan" },
    { firstname: "Jiří", lastname: "Macháček" }
  ]
}
```

Normalized Data Models

References

- Related data in separate documents
 - These are interconnected via directed links (**references**)
 - Technically expressed using **ordinary values with identifiers of target documents** (i.e. no special construct is provided)
- Features: higher flexibility, follow up queries might be needed
- Suitable for **many-to-many** relationships

```
{
  _id: ObjectId("2"),
  title: "Samotáři",
  year: 2000,
  actors: [ ObjectId("6"),
            ObjectId("4"),
            ObjectId("5") ]
}
```

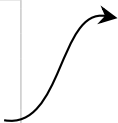

```
{
  _id: ObjectId("6"),
  firstname: "Jitka",
  lastname: "Schneiderová"
}
```

...

Sample Data

Collection of **movies**

```
{
  _id: ObjectId("1"),
  title: "Vratné lahve", year: 2006,
  actors: [ ObjectId("7"), ObjectId("5") ]
}
```

```
{
  _id: ObjectId("2"),
  title: "Samotáři", year: 2000,
  actors: [ ObjectId("6"), ObjectId("4"),
            ObjectId("5") ]
}
```

```
{
  _id: ObjectId("3"),
  title: "Medvídek", year: 2007,
  actors: [ ObjectId("5"), ObjectId("4") ]
}
```

Collection of **actors**

```
{ _id: ObjectId("4"),
  firstname: "Ivan",
  lastname: "Trojan" }
```

```
{ _id: ObjectId("5"),
  firstname: "Jiří",
  lastname: "Macháček" }
```

```
{ _id: ObjectId("6"),
  firstname: "Jitka",
  lastname: "Schneiderová" }
```

```
{ _id: ObjectId("7"),
  firstname: "Zdeněk",
  lastname: "Svěrák" }
```

Application Interfaces

mongo shell

- **Interactive interface to MongoDB**
- `mongosh --username user --password pass --host host --port 28015`

Drivers

- Java, C, C++, C#, Perl, PHP, Python, Ruby, Scala, ...

Query Language

MongoDB query language is based on **JavaScript**

- **Single command / entire script**
- Read queries return a **cursor**
 - Allows us to iterate over all the selected documents
- Each command is always evaluated over a single collection

Query patterns

- Basic **CRUD** operations
 - Accessing documents via identifiers or **conditions on fields**
- Aggregations: **MapReduce**, pipelines, grouping

CRUD Operations

Overview

- `db.collection.insert` | `insertOne` | `insertMany()`
 - Inserts a new document / documents
- `db.collection.replaceOne()`
 - Replaces an existing document
- `db.collection.update` | `updateOne` | `updateMany()`
 - Modifies an existing document / documents
- `db.collection.remove` | `deleteOne` | `deleteMany()`
 - Removes an existing document / documents
- `db.collection.find()`
 - Finds documents based on filtering conditions
 - Projection and / or sorting may be applied too

Insert Operations

Insert Operations

`insertOne` / `insertMany` methods

- Inserts **one new document** into a given collection

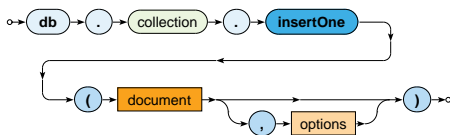

- Inserts **multiple new documents** into a given collection

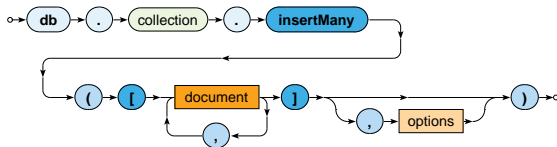

Insert Operations

`insertOne` / `insertMany` methods (cont'd)

- Parameters
 - **Document:** one document to be inserted
 - Provided document identifier (`_id` field) must be unique
 - When missing, it is generated automatically (`ObjectId`)
 - **Options**
- Collections are created automatically when not yet exist

Insert Operations: Examples

Insert a new actor document

```
db.actors.insertOne(  
  {  
    firstname: "Anna",  
    lastname: "Geislerová"  
  }  
)
```

```
{  
  _id: ObjectId("8"),  
  firstname: "Anna",  
  lastname: "Geislerová"  
}
```

Insert two new movies

```
db.movies.insertMany(  
  [  
    {  
      _id: ObjectId("9"), title: "Želary", year: 2003,  
      actors: [ ObjectId("4"), ObjectId("8") ]  
    },  
    { title: "Anthropoid", year: 2016, actors: [ ObjectId("8") ] },  
  ]  
)
```

Replace Operation

Replace Operation

replaceOne method

- Replaces one existing document in a given collection

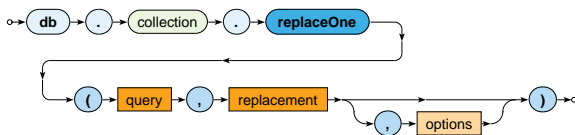

- Parameters
 - **Query:** description of a document to be updated
 - The same behavior as in the find operation
 - When there are more matching documents, just the first one is updated!
 - **Replacement:** new content for a given document
 - **Options**

Replace Operation: Example

Replace the whole document of a specified actor

```
db.actors.replaceOne(  
  { _id: ObjectId("8") },  
  { firstname: "Aňa", lastname: "Geislerová" }  
)
```

```
{  
  _id: ObjectId("8"),  
  firstname: "Aňa",  
  lastname: "Geislerová"  
}
```

Upsert Mode

Upsert mode of the **replace** operation

- When there is no matching document to be updated
⇒ **one new document is inserted** instead
- This mode is activated via an **option**
 - `{ upsert: true }`

What will the new document contain?

- All fields from the `replacement` parameter
- And as for the primary key...
 - Identifier from the query condition is used when supplied
 - Otherwise a new one is generated

Upsert Mode: Example

Unsuccessful update of a movie resulting in insertion

```
db.movies.replaceOne(  
  { title: "Tmavomodrý svět", year: { $gt: 2000 } },  
  {  
    title: "Tmavomodrý svět",  
    director: { firstname: "Jan", lastname: "Svěrák" },  
    year: 2001  
  },  
  { upsert: true }  
)
```

```
{  
  _id: ObjectId("11"),  
  title: "Tmavomodrý svět",  
  director: { firstname: "Jan", lastname: "Svěrák" },  
  year: 2001  
}
```

Update Operations

Update Operations

updateOne / updateMany methods

- Modify the first / all matching documents

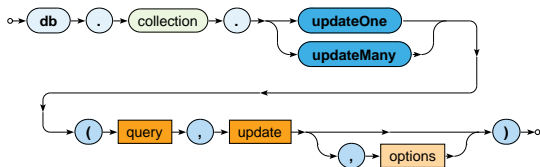

- Parameters
 - **Query:** description of documents to be updated
 - The same behavior as in the find operation
 - **Update:** modification actions to be applied
 - Various **update operators** are available: \$set, \$unset, \$inc, ...
 - Each can only be used at most once
 - **Options**

Update Operations: Example

Update of all movies filmed in 2015 or later

```
db.movies.updateMany(  
  { year: { $gt: 2015 } },  
  {  
    $set: { tag: "New Movies" },  
    $inc: { rating: 3 }  
  }  
)
```

Update Operators

Field operators

- **\$set** – sets the value of a given field / fields

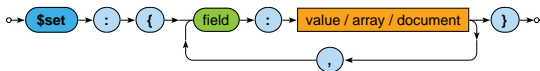

- **\$unset** – removes a given field / fields

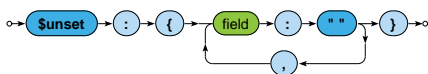

- **\$rename** – renames a given field / fields

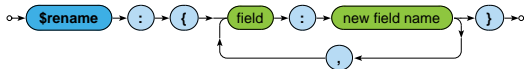

Update Operators

Field operators (cont'd)

- **\$inc** – increments the value of a given field / fields

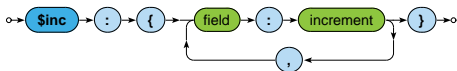

- **\$mul** – multiplies the value of a given field / fields



Update Operators

Array operators

- **\$push** – adds one item / all items to the end of an array

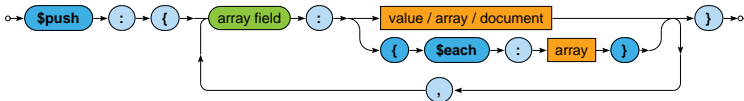

- **\$addToSet** – adds one item / all items to the end of an array, but duplicate values are ignored

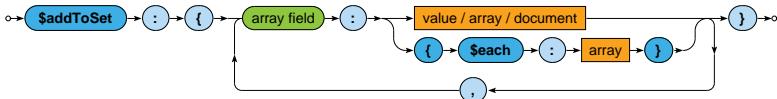

Update Operators

Array operators (cont'd)

- **\$pop** – removes the first / last item of an array

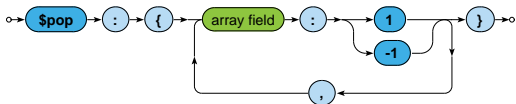

- **\$pull** – removes all array items that match a specified query

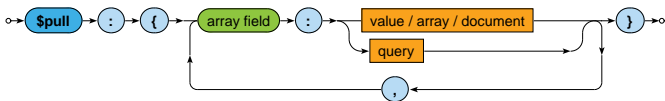

Upsert Mode

Upsert mode of the **update** operations

- When there is no matching document to be updated
⇒ **one new document is inserted** instead
- This mode is activated via an **option**
 - `{ upsert: true }`

What will the new document contain?

- All **value fields** from the query parameter
- As well as the outcome of all the **update operators applied** from the update parameter
- And as for the **primary key...**
 - Identifier from the query condition is used when supplied
 - Otherwise a new one is generated

Upsert Mode: Example

Unsuccessful update of a movie resulting in insertion

```
db.movies.updateOne(  
  { title: "Tmavomodrý svět", year: { $gt: 2000 } },  
  {  
    $set: {  
      director: { firstname: "Jan", lastname: "Svěrák" },  
      year: 2001  
    },  
    $inc: { rating: 2 }  
  },  
  { upsert: true }  
)
```

```
{ _id: ObjectId("11"),  
  title: "Tmavomodrý svět",  
  director: { firstname: "Jan", lastname: "Svěrák" },  
  year: 2001,  
  rating: 2 }
```

Delete Operations

Delete Operations

deleteOne / deleteMany methods

- Remove the first / all matching documents

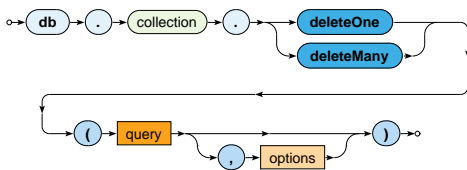

- Parameters
 - Query:** description of documents to be removed
 - The same behavior as in the find operation
 - Options**

Find Operation

Find Operation

find method

- Selects matching documents from a given collection

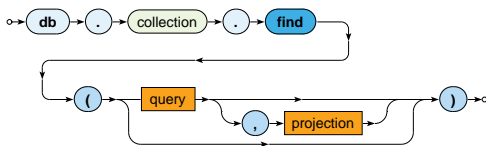

- Parameters
 - **Query:** description of documents to be selected
 - **Projection:** fields to be included / excluded in the result
- Matching documents are returned via an iterable `cursor`
 - This allows us to chain further `sort`, `skip` or `limit` operations

Find Operation: Examples

Select all movies from our collection

```
db.movies.find()
```

```
db.movies.find( { } )
```

Select a particular movie based on its document identifier

```
db.movies.find( { _id: ObjectId("2") } )
```

Select movies filmed in *2000* with a rating greater than *1*

```
db.movies.find( { year: 2000, rating: { $gt: 1 } } )
```

Select movies filmed between *2005* and *2015*

```
db.movies.find( { year: { $gte: 2005, $lte: 2015 } } )
```

Selection

Query parameter describes the documents we are interested in

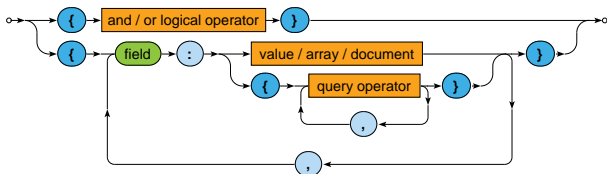

Boolean expression with one top-level logical operator: \$and, \$or
Conditions on individual distinct fields

- **Value equality**
 - The actual field value must be identical to the specified value
- **Query operators**
 - The actual field value must satisfy all the provided operators

Selection: Field Conditions

Value equality

- The actual field value must be identical to the specified value
- I.e. identical...
 - including the number, order and names of recursively identical values of all nested **object fields**
 - including the number and order of recursively identical **array items**

Query operators

- The actual field value must satisfy all the provided operators
 - Each operator can be used at most once

Value Equality: Examples

Select movies having a specific director

```
db.movies.find(  
  { director: { firstname: "Jan", lastname: "Svěrák" } }  
)
```

```
db.movies.find(  
  { director: { lastname: "Svěrák", firstname: "Jan" } }  
)
```

Select movies having specific actors

```
db.movies.find( { actors: [ ObjectId("7"), ObjectId("5") ] } )
```

```
db.movies.find( { actors: [ ObjectId("5"), ObjectId("7") ] } )
```

Queries in both the pairs are not equivalent!

Dot Notation

The **dot notation** for field names

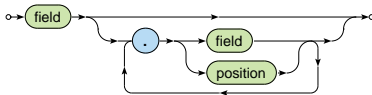

- Accessing **fields of embedded documents**
 - `"field.subfield"`
 - E.g.: `"director.firstname"`
- Accessing **items of arrays**
 - `"field.index"`
 - E.g.: `"actors.2"`
 - Positions start at 0

Value Equality

Example (revisited)

Select movies having a specific director

```
db.movies.find(  
  { director: { firstname: "Jan", lastname: "Svěrák" } }  
)
```

```
db.movies.find(  
  { "director.firstname": "Jan", "director.lastname": "Svěrák" }  
)
```

Query Operators

Comparison operators

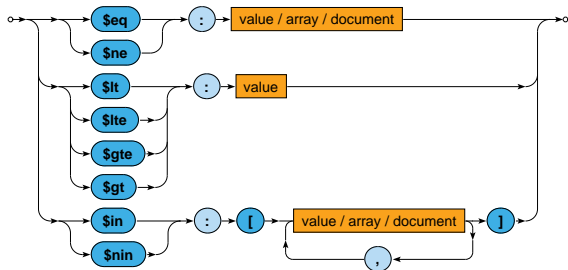

- Comparisons take particular **BSON** data types into account
 - Certain numeric conversions are automatically applied

Query Operators

Comparison operators

- **\$eq, \$ne**
 - Tests the actual field value for **equality / inequality**
 - The same behavior as in case of value equality conditions
- **\$lt, \$lte, \$gte, \$gt**
 - Tests whether the actual field value is **less than / less than or equal / greater than or equal / greater than** the provided value
- **\$in**
 - Tests whether the actual field value is equal to **at least one** of the provided values
- **\$nin**
 - Negation of \$in

Query Operators

Element operators

- **\$exists** – tests whether a given field **exists / not exists**

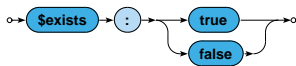

Evaluation operators

- **\$regex** – tests whether a given field value matches a specified **regular expression** (PCRE)
- **\$text** – performs **text search** (text index must exist)

Query Operators

Array operators

- **\$all** – tests whether a given array **contains all the specified items** (in any order)

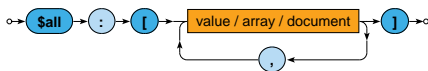

Example (revisited)

Select movies having specific actors

```
db.movies.find(  
  { actors: [ ObjectId("5"), ObjectId("7") ] }  
)
```

```
db.movies.find(  
  { actors: { $all: [ ObjectId("5"), ObjectId("7") ] } }  
)
```

Query Operators

Array operators (cont'd)

- **\$size** – tests the size of a given array against a fixed number (and not, e.g., a range, unfortunately)



- **\$elemMatch** – tests whether a given array **contains at least one item** that satisfies all the involved query operations



Query Operators

Logical operators

- **\$and, \$or**

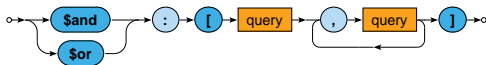

- Logical connectives for **conjunction / disjunction**
- At least 2 involved query expressions must be provided
- **Only allowed at the top level** of a query

- **\$not**

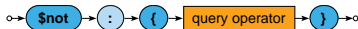

- Logical **negation** of exactly one involved query operator
- I.e. **cannot be used at the top level** of a query

Querying Arrays

Condition based on **value equality** is satisfied when...

- the given field as a whole is identical to the provided value, or
- at least one item of the array is identical to the provided value

```
db.movies.find( { actors: ObjectId("5") } )
```

```
{ actors: ObjectId("5") }
```

```
{ actors: [ ObjectId("5"), ObjectId("7") ] }
```

Querying Arrays

Condition based on **query operators** is satisfied when...

- the given field as a whole satisfies all the involved operators, or
- each of the involved operators is satisfied by at least one item of the given array
 - note, however, that this item **may not be the same** for all the individual operators

```
db.movies.find( { ratings: { $gte: 2, $lte: 3 } } )
```

```
{ ratings: 3 }
```

```
{ ratings: [ 3, 7, 5 ] }
```

```
{ ratings: [ 1, 4 ] }
```

Use `$elemMatch` when just a single array item should be found for all the operators

Projection

Projection allows us to determine the fields returned in the result

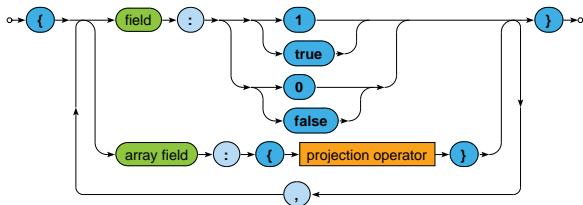

- **true** or **1** for fields to be **included**
- **false** or **0** for fields to be **excluded**
- Positive and negative enumerations cannot be combined!
 - The only exception is `_id` which is **included by default**
- **Projection operators** – allow to select particular array items

Projection Operators

Array operators

- **\$elemMatch** – selects the first matching item of an array
This item must satisfy all the operators included in query
When there is no such item, the field is not returned at all



- **\$slice** – selects the first count items of an array (when count is positive) / the last count items (when negative)
Certain number of items can also be skipped

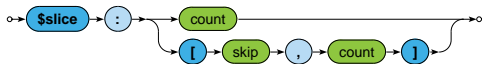

Projection: Examples

Find a particular movie, select its identifier, title and actors

```
db.movies.find(  
  { _id: ObjectId("2") },  
  { title: true, actors: true }  
)
```

```
{  
  _id: ObjectId("2"),  
  title: "Samotáři",  
  actors: [ ObjectId("6"),  
            ObjectId("4"),  
            ObjectId("5") ]  
}
```

Find movies from 2000, select their titles and the last two actors

```
db.movies.find(  
  { year: 2000 },  
  {  
    title: 1, _id: 0,  
    actors: { $slice: -2 }  
  }  
)
```

```
{  
  title: "Samotáři",  
  actors: [ ObjectId("4"),  
            ObjectId("5") ]  
}
```

Modifiers

Modifiers change the order and number of returned documents

- **sort** – orders the documents in the result
- **skip** – skips a certain number of documents from the beginning



- **limit** – returns at most a certain number of documents



All the modifiers are optional, can be chained in any order (without any implications), but **must all be specified before any documents are retrieved** via a given cursor

Modifiers

Sort modifier orders the documents in the result

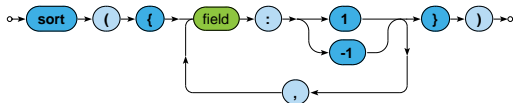

- 1 for **ascending**, -1 for **descending** order
- The order of documents is undefined unless explicitly sorted
- Sorting of larger datasets should be supported by indices
- **Sorting happens before the projection phase**
 - I.e. not included fields can be used for sorting purposes as well

Index Structures

Index Structures

Motivation

- Full **collection scan** must be conducted when searching for documents **unless an appropriate index exists**

Primary index

- Unique index on values of the **_id field**
- Created automatically

Secondary indexes

- Created manually for values of a given key field / fields
- Always within just a single collection

Index Structures

Secondary index creation

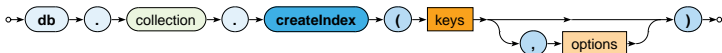

Definition of keys (fields) to be involved

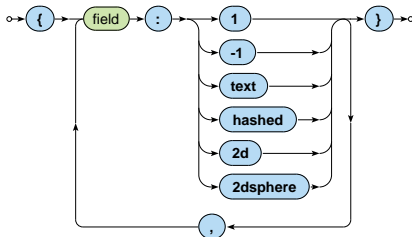

Index Structures

Index types

- `1`, `-1` – standard ascending / descending value indexes
 - Both scalar values and embedded documents can be indexed
- `hashed` – hash values of a single field are indexed
- `text` – basic full-text index
- `2d` – points in planar geometry
- `2dsphere` – points in spherical geometry

Index Structures

Index forms

- One key / multiple keys (**composed index**)
- Ordinary fields / array fields (**multi-key index**)

Index properties

- **Unique** – duplicate values are rejected (cannot be inserted)
- **Partial** – only certain documents are indexed
- **Sparse** – documents without a given field are ignored
- **TTL** – documents are removed when a timeout elapses

Just some type / form / property combinations can be used!

Index Structures

Execution plan

```
db.movies.find({ title: "Medvídek" }).explain()
```

Index creation

```
db.movies.createIndex({ title: 1 })
```

MapReduce

MapReduce

Executes a **MapReduce** job on a selected collection

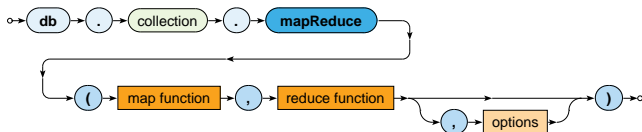

- Parameters
 - **Map**: JavaScript implementation of the Map function
 - **Reduce**: JavaScript implementation of the Reduce function
 - **Options**

MapReduce

Map function

- Current document is accessible via `this`
- `emit(key, value)` is used for emissions

Reduce function

- Intermediate key and values are provided as arguments
- Reduced value is published via `return`

Options

- `query`: only matching documents are considered
- `sort`: they are processed in a specific order
- `limit`: at most a given number of them is processed
- `out`: output is stored into a given collection

MapReduce: Example

Count the number of movies filmed in each year, starting in 2005

```
db.movies.mapReduce(  
  function() {  
    emit(this.year, 1);  
  },  
  function(key, values) {  
    return Array.sum(values);  
  },  
  {  
    query: { year: { $gte: 2005 } },  
    sort: { year: 1 },  
    out: "statistics"  
  }  
)
```

Lecture Conclusion

MongoDB

- Document database for **JSON documents**
- **Sharding with master-slave replication architecture**

Query functionality

- CRUD operations
 - **Insert, find, update, remove**
 - Complex filtering conditions
- Index structures
- MapReduce